

- AT-AR3050S
- AT-AR4050S

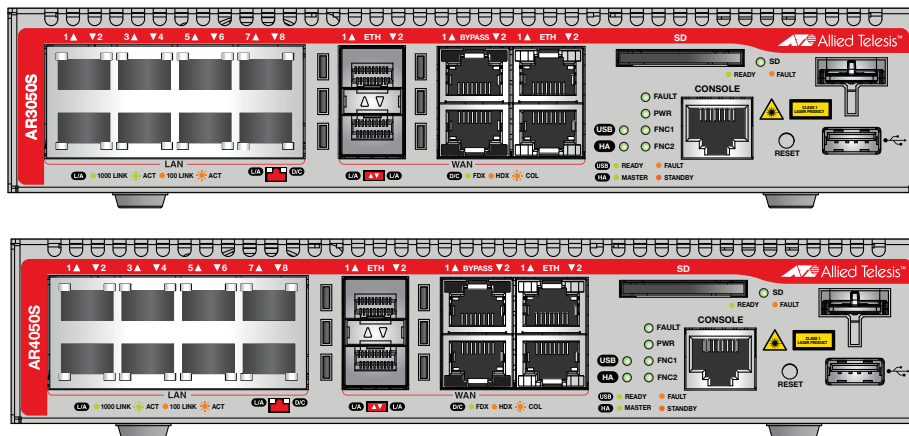

# Installation Guide

Copyright © 2015 Allied Telesis, Inc.

All rights reserved. No part of this publication may be reproduced without prior written permission from Allied Telesis, Inc.

Allied Telesis and the Allied Telesis logo are trademarks of Allied Telesis, Incorporated. All other product names, company names, logos or other designations mentioned herein are trademarks or registered trademarks of their respective owners.

Allied Telesis, Inc. reserves the right to make changes in specifications and other information contained in this document without prior written notice. The information provided herein is subject to change without notice. In no event shall Allied Telesis, Inc. be liable for any incidental, special, indirect, or consequential damages whatsoever, including but not limited to lost profits, arising out of or related to this manual or the information contained herein, even if Allied Telesis, Inc. has been advised of, known, or should have known, the possibility of such damages.

# Electrical Safety and Emissions Standards

---

This product meets the following standards.

## U.S. Federal Communications Commission

### Radiated Energy

Note: This equipment has been tested and found to comply with the limits for a Class A digital device pursuant to Part 15 of FCC Rules. These limits are designed to provide reasonable protection against harmful interference when the equipment is operated in a commercial environment. This equipment generates, uses, and can radiate radio frequency energy and, if not installed and used in accordance with this instruction manual, may cause harmful interference to radio communications. Operation of this equipment in a residential area is likely to cause harmful interference in which case the user will be required to correct the interference at his own expense.

Note: Modifications or changes not expressly approved of by the manufacturer or the FCC, can void your right to operate this equipment.

## Industry Canada

This Class A digital apparatus complies with Canadian ICES-003.

Cet appareil numérique de la classe A est conforme à la norme NMB-003 du Canada.

**Warning:** In a domestic environment this product may cause radio interference in which case the user may be required to take adequate measures.

EMC: AS/NZS CISPR22 class A, EN55022 Class A, EN55024, EN61000-3-2, EN61000-3-3, FCC Part 15 (CFR 47) Class A, ICES-003, VCCI-A

Electrical Safety: IEC 60950-1, CAN/CSA-C22.2 No.60950-1, EN60950-1, UL 60950-1

Environmental Compliance: 2011/65/EU RoHS Directive



Laser Safety

EN60825-1

# Translated Safety Statements

---

**Important:** Safety statements that have the  symbol are translated into multiple languages in the *Translated Safety Statements* document at [www.alliedtelesis.com/support](http://www.alliedtelesis.com/support).

# Contents

---

<b>Preface</b> .....	11
Document Conventions .....	12
Contacting Allied Telesis .....	13
<b>Chapter 1: Overview</b> .....	15
Features .....	16
10/100/1000 Mbps Twisted Pair Ports .....	16
WAN Ports .....	16
USB Port .....	16
USB Retainer Slot .....	16
SD Card Slot .....	16
Reset Button .....	16
High Availability .....	16
LEDs .....	16
Kensington lock hole .....	17
Installation Options .....	17
Management Software and Interfaces .....	17
Management Methods .....	17
Package Contents .....	18
Front and Back Panels .....	19
Management Panel .....	21
Management Software .....	22
Twisted Pair Ports .....	23
WAN Ports .....	24
ETH Ports (RJ-45) .....	24
ETH Ports (SFP) .....	24
Bypass Ports .....	24
LEDs .....	26
Power LED .....	26
Fault LED .....	26
High Availability LED .....	27
USB LED .....	28
SD Card LED .....	29
LEDs for the ETH 1 and ETH 2 Ports (RJ-45) .....	30
LEDs for the Twisted Pair LAN Ports .....	31
LEDs for the ETH 1 and ETH 2 Ports (SFP) .....	33
Function 1 LED .....	33
Function 2 LED .....	34
USB Port .....	35
USB Retainer Slot .....	36
SD Card Slot .....	39
Console Port .....	40
Reset Button .....	41
Power Supply .....	42
<b>Chapter 2: Beginning the Installation</b> .....	43
Reviewing Safety Precautions .....	44
Choosing a Site for the Routers .....	48
Unpacking the Router .....	49

<b>Chapter 3: Installing the Router and Powering on the Router</b> .....	51
Installing the Router on a Table or Desktop .....	53
<b>Chapter 4: Cabling the Networking Ports</b> .....	67
Cabling the Twisted Pair Ports .....	68
<b>Chapter 5: Troubleshooting</b> .....	73
<b>Appendix A: Technical Specifications</b> .....	77
Physical Specifications .....	77
Environmental Specifications.....	77
Power Specifications .....	78
Certifications .....	78
RJ-45 Twisted Pair Port Pinouts.....	79
RJ-45 Style Serial Console Port Pinouts .....	80

# Figures

---

Figure 1: Front panel of the AT-AR3050S router.....	19
Figure 2: Front panel of the AT-AR4050S router.....	19
Figure 3: Back panel of the AT-AR3050S and AT-AR4050S routers.....	20
Figure 4: AT-AR3050S and AT-AR4050S management panel.....	21
Figure 5: Power LED.....	26
Figure 6: Fault LED.....	27
Figure 7: HA LED.....	27
Figure 8: USB LED.....	28
Figure 9: SD Card LED.....	29
Figure 10: ETH Port (RJ-45) LEDs.....	30
Figure 11: LEDs for the 10/100/1000Base-T Ports.....	32
Figure 12: LEDs for ETH 1 and ETH 2 Ports (SFP).....	33
Figure 13: Function 1 LED.....	34
Figure 14: Function 2 LED.....	34
Figure 15: USB port.....	35
Figure 16: USB retainer slot.....	36
Figure 17: USB retainer.....	37
Figure 18: Attaching the USB retainer.....	37
Figure 19: Attaching the cable tie.....	38
Figure 20: SD card slot.....	39
Figure 21: Console port.....	40
Figure 22: Reset button.....	41
Figure 23: Components of the AT-AR3050S and AT-AR4050S routers.....	49
Figure 24: Power cord retaining clip.....	52
Figure 25: Inserting the retaining clip into the retaining bracket.....	52
Figure 26: Attaching the rubber feet.....	54
Figure 27: Turning the router upside down.....	55
Figure 28: Removing the rubber feet.....	56
Figure 29: Attaching handles to the brackets.....	56
Figure 30: Attaching the equipment rack brackets.....	57
Figure 31: Mounting the router horizontally in an equipment rack.....	57
Figure 32: Attaching the wall mount brackets to the side of the router.....	59
Figure 33: Making the anchor hole locations.....	60
Figure 34: Securing the router to the wall.....	61
Figure 35: Power cord retaining clip in the up position.....	62
Figure 36: Connecting the AC power cord.....	63
Figure 37: Connecting the Management Cable to the Console Port.....	64
Figure 38: Router initialization messages.....	65
Figure 39: Router initialization messages (Continued).....	66
Figure 40: Removing the dust plug from an SFP slot.....	70
Figure 41: Installing an SFP transceiver.....	71
Figure 42: Removing the dust cover from an SFP transceiver.....	71
Figure 43: Positioning the SFP handle in the upright position.....	72
Figure 44: Connecting a fiber optic cable to an SFP transceiver.....	72
Figure 45: RJ-45 Socket Pin Layout (Front View).....	79





# Tables

---

Table 1: Power LED .....	26
Table 2: Fault LED .....	27
Table 3: High Availability LED .....	28
Table 4: USB LED .....	29
Table 5: SD Card LED .....	30
Table 6: LEDs for ETH 1 and ETH 2 Ports (RJ-45) .....	31
Table 7: LEDs for the Twisted Pair LAN Ports .....	32
Table 8: LEDs for ETH 1 and ETH 2 ports (SFP) .....	33
Table 9: Product Dimensions .....	77
Table 10: Product Weights .....	77
Table 11: Environmental Specifications .....	77
Table 12: Maximum Power Consumptions .....	78
Table 13: Input Voltages .....	78
Table 14: Product Certifications .....	78
Table 15: Pin Signals for 10 and 100 Mbps .....	79
Table 16: Pin Signals for 1000 Mbps .....	79
Table 17: RJ-45 Style Serial Console Port Pin Signals .....	80



# Preface

---

This guide contains the installation instructions for the AT-AR3050S and AT-AR4050S routers. This preface contains the following sections:

- “Document Conventions” on page 10
- “Contacting Allied Telesis” on page 11

## Document Conventions

---

This document uses the following conventions:

---

**Note**

Notes provide additional information.

---



---

**Caution**

Cautions inform you that performing or omitting a specific action may result in equipment damage or loss of data.

---



---

**Warning**

Warnings inform you that performing or omitting a specific action may result in bodily injury.

---

## Contacting Allied Telesis

---

If you need assistance with this product, you may contact Allied Telesis technical support by going to the Support & Services section of the Allied Telesis web site at **[www.alliedtelesis.com/support](http://www.alliedtelesis.com/support)**. You can find links for the following services on this page:

- ❑ 24/7 Online Support — Enter our interactive support center to search for answers to your product questions in our knowledge database, to check support tickets, to learn about RMAs, and to contact Allied Telesis technical experts.
- ❑ USA and EMEA phone support — Select the phone number that best fits your location and customer type.
- ❑ Hardware warranty information — Learn about Allied Telesis warranties and register your product online.
- ❑ Replacement Services — Submit a Return Merchandise Authorization (RMA) request via our interactive support center.
- ❑ Documentation — View the most recent installation and user guides, software release notes, white papers, and data sheets for your products.
- ❑ Software Downloads — Download the latest software releases for your managed products.

For sales or corporate information, go to **[www.alliedtelesis.com/purchase](http://www.alliedtelesis.com/purchase)** and select your region.



## Chapter 1

# Overview

---

This chapter contains the following sections:

- ❑ “Features” on page 12
- ❑ “Package Contents” on page 14
- ❑ “Front and Back Panels” on page 15
- ❑ “Management Panel” on page 17
- ❑ “Management Software” on page 18
- ❑ “Twisted Pair Ports” on page 19
- ❑ “WAN Ports” on page 20
- ❑ “LEDs” on page 22
- ❑ “USB Port” on page 31
- ❑ “USB Retainer Slot” on page 32
- ❑ “SD Card Slot” on page 35
- ❑ “Console Port” on page 36
- ❑ “Reset Button” on page 37
- ❑ “Power Supply” on page 38

## Features

---

Here are the features of the AR3050S and AR4050S routers.

### **10/100/1000 Mbps Twisted Pair Ports**

Here are the basic features of the 10/100/1000 Mbps twisted pair ports.

- 8 LAN ports per router
- 10Base-T (IEEE 802.3i), 100Base-TX (IEEE 802.3u), and 1000Base-T (IEEE 802.3ab) compliant
- IEEE 802.3u Auto-Negotiation compliant
- Auto-MDI/MDIX
- 100 meters (328 feet) maximum operating distance
- RJ-45 connectors

### **WAN Ports**

Here are the basic features of the WAN ports.

- Supports two ETH ports
- Supports two bypass ports
- Supports two SFP slots

### **USB Port**

Used for maintenance.

### **USB Retainer Slot**

- Used in conjunction with the USB retainer kit
- Used for preventing the USB device from falling out the router

### **SD Card Slot**

Here are the basic features of the SD card slot.

- Used for maintenance
- Used for autoboot feature
- Supports storage capacity up to 32GB

### **Reset Button**

Here are the basic features of the reset button.

- Returns to factory default settings
- Reboots the router

### **High Availability**

- Two bypass ports per router

### **LEDs**

Here are the LEDs.

- Power LED
- Fault LED



- High Availability LED
- USB LED
- SD card LED
- Duplex/collision and link/activity LEDs for the twisted pair ETH ports (RJ45)
- Duplex/collision and link/activity LEDs for the twisted pair LAN ports
- Link/activity LEDs for the ETH ports (SFP)
- Function 1 LED
- Function 2 LED

### **Kensington Lock Hole**

Here are the basic features of the Kensington lock hole.

- Used for attaching a lock-and-cable apparatus
- One hole located on the center of the back panel

### **Installation Options**

Here are the installation options for the routers.

- Desk or tabletop
- 19-inch equipment rack - horizontal mounting
- Wall mounted

### **Management Software and Interfaces**

Here are the management software and interfaces.

- AlliedWare Plus™ Operating System
- Command line interface
- Web browser interface

### **Management Methods**

Here are the methods for managing the routers.

- Local management through the Console port
- Remote Telnet and Secure Shell management
- Remote web browser management
- SNMPv1, v2c, and v3

## Package Contents

---

- ❑ 1 main unit
- ❑ 1 AC power cable
- ❑ 1 addendum document sheet
- ❑ 1 AC power cord retainer
- ❑ 1 USB retainer
- ❑ 1 double-side adhesive tape
- ❑ 2 cable ties
- ❑ 4 stick-on rubber feet kit
- ❑ 1 RS-232 console cable

## Front and Back Panels

The front panel of the AT-AR3050S router is shown in Figure 1.

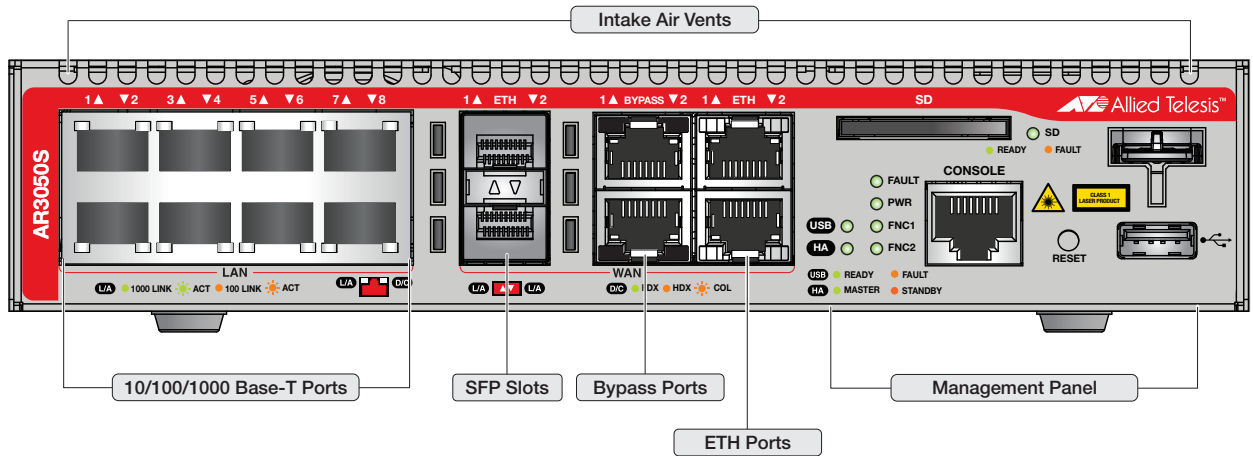

Figure 1. Front panel of the AT-AR3050S router

The front panel of the AT-AR4050S router is shown in Figure 2.

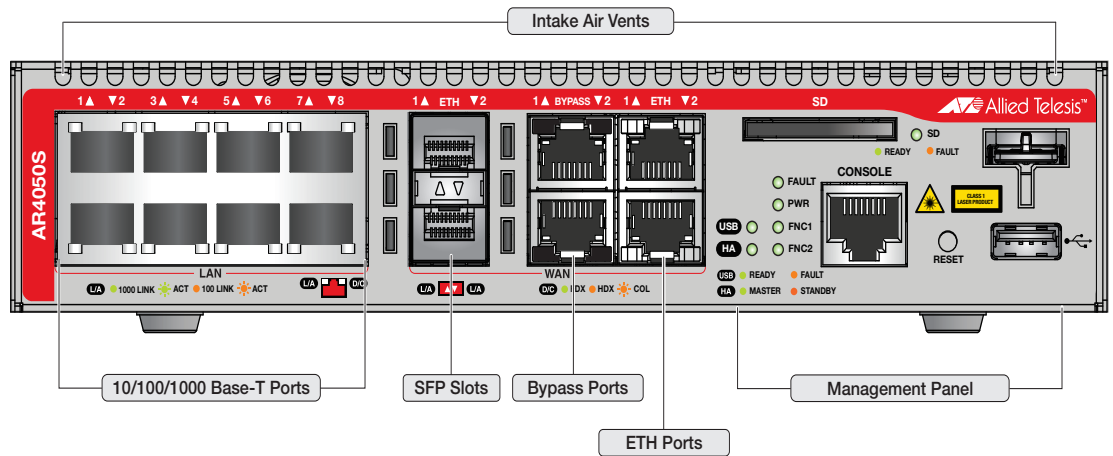

Figure 2. Front panel of the AT-AR4050S router

The back panel of the AT-AR3050S and AT-AR4050S routers is shown in Figure 3.

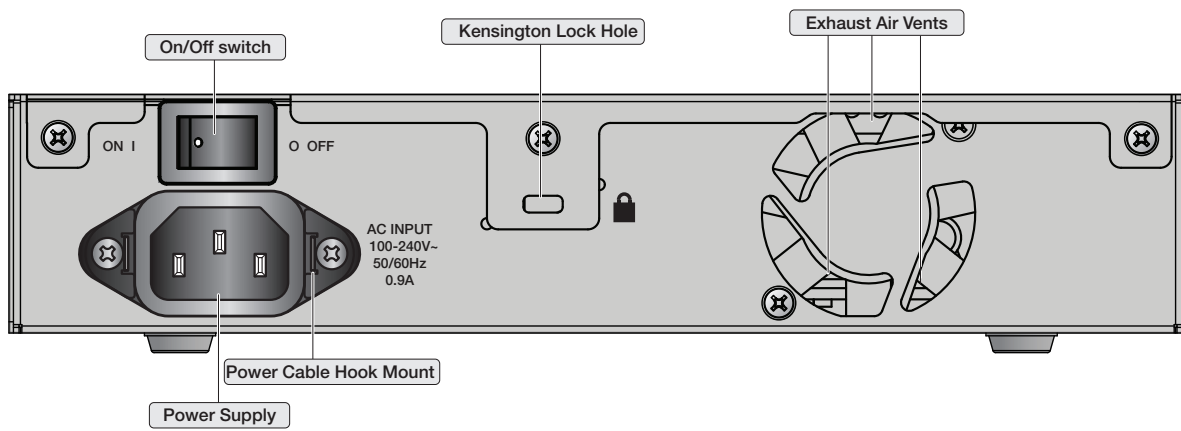

Figure 3. Back panel of the AT-AR3050S and AT-AR4050S routers

## Management Panel

---

Figure 4 identifies the components in the management panel on the AT-AR3050S and AT-AR4050S routers.

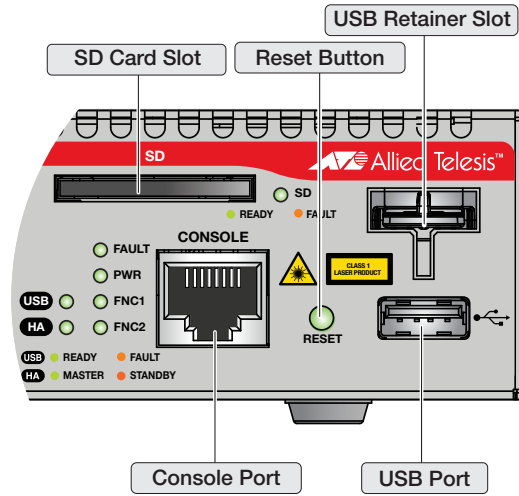

Figure 4. AT-AR3050S and AT-AR4050S management panel

## Management Software

---

The routers are shipped with the management software pre-installed. The software provides a Command Line Interface (CLI) and a Graphical User Interface (GUI) for in-band, over-the-network management.

In the unlikely event that the management software becomes corrupted or damaged on the router, you can download the software from the Allied Telesis corporate web site and reinstall it on the router. For instructions on how to install new management software, see the production documentation.

## Twisted Pair Ports

---

The AT-AR3050S and AT-AR4050S routers both feature 8 twisted pair LAN ports and 2 twisted pair ETH ports for WAN connection. All ports are 10Base-T, 100Base-TX, and 1000Base-T compliant. You can set the port speeds and duplex modes either automatically with IEEE 802.3u Auto-Negotiation or manually with the management software.

The twisted pair ports feature 8-pin RJ-45 connectors. For the port pinouts, see “RJ-45 Twisted Pair Port Pinouts” on page 35.

The ports have a maximum operating distance of 100 m (328 feet). For 10 Mbps operation, the ports require Category 3 or better 100 ohm shielded or unshielded twisted pair cabling. For 100 or 1000 Mbps operation, the ports require Category 5 or Enhanced Category 5 (5E) 100 ohm shielded or unshielded twisted pair cabling.

---

**Note**

A router port connected to an end node that is not using Auto-Negotiation should not use Auto-Negotiation to set the speed and duplex mode, because a duplex mode mismatch may occur. In this case, disable Auto-Negotiation and set the port’s speed and duplex mode manually.

---

## WAN Ports

---

### ETH Ports (RJ-45)

The routers have two ETH ports (RJ-45) that support 10/100/1000 Mbps twisted pair ports.

The ETH ports are located between the management panel and the bypass ports. The upper port is ETH 1 port and the lower port is ETH 2 port.

You can use one of the ETH ports to connect the router to the WAN. ETH 1 and ETH 2 ports both support bypass ports.

### ETH Ports (SFP)

The routers have two ETH ports (SFP slots) that support 1000Base-X SFP transceivers which are in accordance with IEEE802.3u and IEEE802.3z.

The ETH ports are located between the LAN ports and bypass ports.

You may use the SFP transceivers to connect routers to the WAN.

---

**Note**

You can use either the transceivers or the ETH ports (RJ-45) to connect routers to the WAN. You can use ETH1 or SFP1, but not both at the same time. You can use ETH2 or SFP2, but not both at the same time.

---

---

**Note**

Note that the high availability functionality is for the copper ports only and is not available if SFPs are used.

---

You may also use the transceivers to connect routers to other network devices over large distances, build high-speed backbone networks between network devices, or connect high-speed devices, such as servers, to your network.

---

**Note**

SFP transceivers must be purchased separately. For a list of supported transceivers, contact your Allied Telesis distributor or reseller.

---

### Bypass Ports

The routers have two bypass ports. You can use the bypass ports to connect the master router to backup routers to maintain the incoming WAN link.

You may connect an ETH port of the master router to the incoming WAN



link to the building and connect a bypass port of the master router to an ETH port of an identical backup router. The bypass port of the master router is only active and in the bypass mode if:

- ❑ The master router has no power supply or suffers an internal fault, then the incoming WAN link is bypassed to the ETH port of the backup router.
- ❑ The master router is active but unable to boot because of some critical issues, then the incoming WAN link is bypassed to the backup router.
- ❑ The router is under software control because of some trigger events. For example, if the master router is active and a manual override command is given via the CLI, then the incoming WAN link is bypassed to the backup router.

Note that if the master router is active and is able to boot normally, then the master router connects to the WAN link, the bypass port is inactive and the backup router will not see a link to the WAN on its ETH port.

# LEDs

Here are the descriptions of the LEDs.

**Power LED** The Power LED reports the status of AC power. The LED is shown in Figure 5.

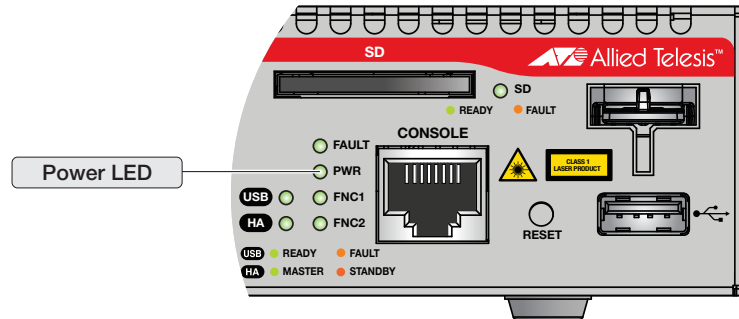

Figure 5. Power LED

The LED is described in Table 1.

Table 1. Power LED

LED	State	Description
Power	Off	The router is not receiving AC power.
	Steady Green	The router is receiving AC input power and is operating normally.

**Fault LED** The Fault LED reports the status of the router. The LED is shown in Figure 6.

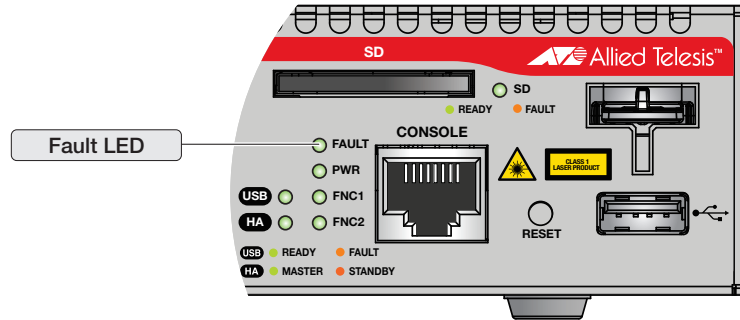

Figure 6. Fault LED

The LED is described in Table 2.

Table 2. Fault LED

LED	State	Description
Fault	Off	The router is operating normally.
	1 Red Flash	Indicates a fan fault
	2 Red Flashes	Indicate a power (voltage) fault
	6 Red Flashes	Indicates a temperature fault

### High Availability LED

The High Availability (HA) LED reports the connectivity status of the router.

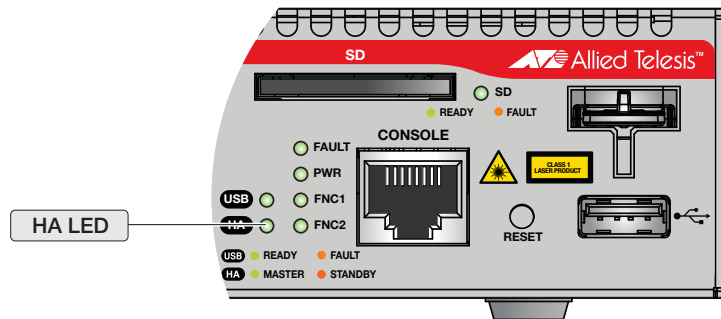

Figure 7. HA LED

The LED is described in Table 3.

Table 3. High Availability LED

LED	State	Description
High Availability	Off	No HA-Mode VRRP (Virtual Router Redundancy Protocol) instances are configured on the router.
	Steady Green	An HA-Mode VRRP instance on the router is in master state.
	Steady Yellow	An HA-Mode VRRP instance on the router is in backup state and no failover has occurred.
	Blinking Yellow	An HA-Mode VRRP instance is in backup state after having failed over from master state.
		An HA-Mode VRRP instance is in init state (administratively disabled or the VRRP link is down).

**USB LED**

The USB LED reports the status of the USB device. The USB memory mode and USB modem mode share the same USB LED. The LED is shown in Figure 8.

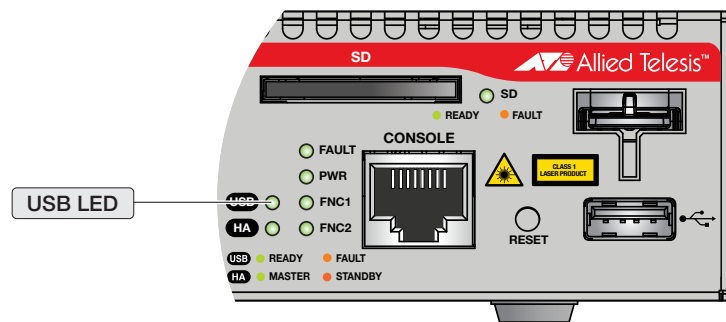

Figure 8. USB LED

The LED is described in Table 4.

Table 4. USB LED

LED	State	Description
Memory Mode and Modem Mode	Off	No USB device is attached.
	Steady Yellow	USB device is experiencing failure.
Memory Mode	Steady Green	USB storage device is mounted correctly.
Modem Mode	Steady Green	USB modem device is recognized.

**SD Card LED**

The SD card LED reports the status of the SD card. The LED is shown in Figure 9.

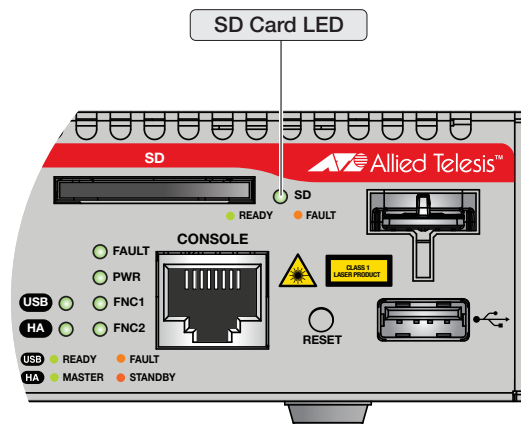

Figure 9. SD Card LED

The LED is described in Table 5.

Table 5. SD Card LED

LED	State	Description
SD Card	Off	No SD card is attached.
	Steady Green	SD card is attached and recognized.
	Blinking Green	SD card activity is in read or write.
	Blinking Yellow	SD card is experiencing failure.

**LEDs for the ETH 1 and ETH 2 Ports (RJ-45)**

Each twisted pair port on the routers has two LEDs that display link, activity, duplex and collision information. The LEDs are shown in Figure 10.

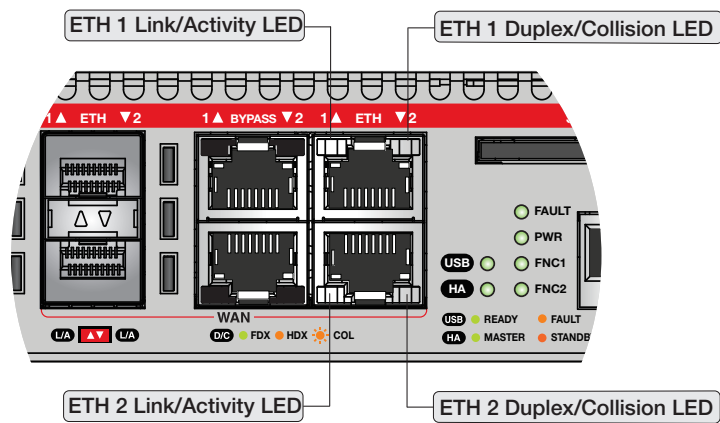

Figure 10. ETH Port (RJ-45) LEDs

The LEDs are described in Table 6.

Table 6. LEDs for ETH 1 and ETH 2 Ports (RJ-45)

LED	State	Description
Link/ Activity LED	Solid Green	A port has established a 1000 Mbps link to a network device.
	Blinking Green	A port is transmitting or receiving data at 1000 Mbps.
	Solid Yellow	A port has established a 10 Mbps or 100 Mbps link to a network device.
	Blinking Yellow	A port is transmitting or receiving data at 10 or 100 Mbps.
	Off	A port has not established a link with another network device.
Duplex Mode LED	Solid Green	A port is operating in full duplex mode.
	Solid Yellow	A port is operating in half-duplex mode at 10 or 100 Mbps. (Half-duplex mode does not apply to 1000 Mbps operation.)
	Blinking Yellow	Collisions are occurring on a port operating at 10 or 100 Mbps.
	Off	A port has not established a link with another network device.

### LEDs for the Twisted Pair LAN Ports

Each twisted pair port on the AT-AR3050S and AT-AR4050S routers has two LEDs that display link, activity, duplex and collision information. The LEDs are shown in Figure 11.

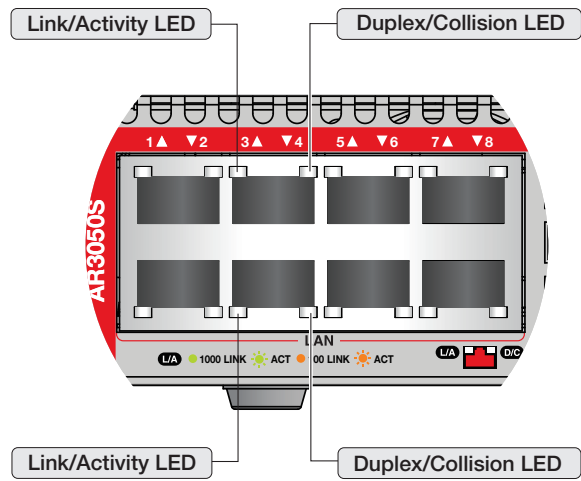

Figure 11. LEDs for the 10/100/1000Base-T Ports

The LEDs are described in Table 7.

Table 7. LEDs for the Twisted Pair LAN Ports

LED	State	Description
Link/ Activity LED	Solid Green	A port has established a 1000 Mbps link to a network device.
	Blinking Green	A port is transmitting or receiving data at 1000 Mbps.
	Solid Yellow	A port has established a 10 or 100 Mbps link to a network device.
	Blinking Yellow	A port is transmitting or receiving data at 10 or 100 Mbps.
	Off	A port has not established a link with another network device.
Duplex/ Collision Mode LED	Solid Green	A port is operating in full duplex mode.
	Solid Yellow	A port is operating in half-duplex mode at 10 or 100 Mbps. (Half-duplex mode does not apply to 1000 Mbps operation.)
	Blinking Yellow	Collisions are occurring on a port operating at 10 or 100 Mbps.



Table 7. LEDs for the Twisted Pair LAN Ports

LED	State	Description
	Off	A port has not established a link with another network device.

### LEDs for the ETH 1 and ETH 2 Ports (SFP)

The LEDs for the ETH 1 and ETH 2 ports (SFP) are located between the slots, as shown in Figure 12. Each SFP slot has one LED. The left-hand LED is for the top slot and the right-hand LED is for the bottom slot.

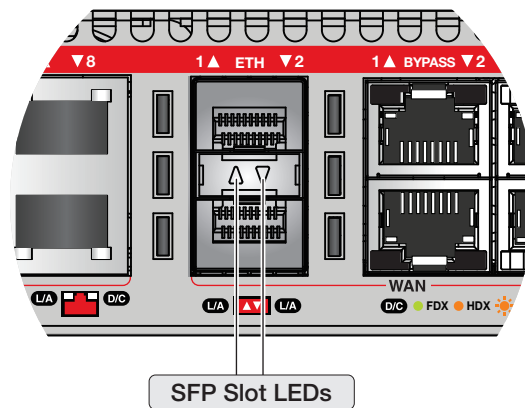

Figure 12. LEDs for ETH 1 and ETH 2 Ports (SFP)

Table 8. LEDs for ETH 1 and ETH 2 ports (SFP)

LED	State	Description
ETH 1 and ETH 2 (SFP)	Off	The slot is empty, the SFP transceiver has not established a link to a network device.
	Solid Green	The SFP transceiver has established a link at 1000 Mbps with a network device.
	Blinking Green	The SFP transceiver is receiving or transmitting packets with a network device at 1000 Mbps.

### Function 1 LED

The Function 1 LED is shown in Figure 13. The Function 1 LED is user configurable and controlled by trigger actions.

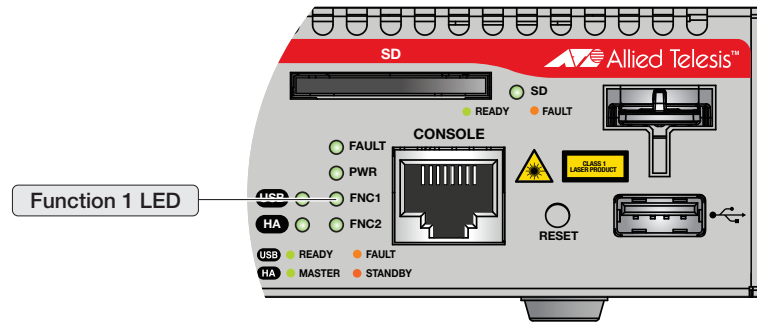

Figure 13. Function 1 LED

### Function 2 LED

The Function 2 LED is shown in Figure 14. The Function 2 LED is user configurable and controlled by trigger actions.

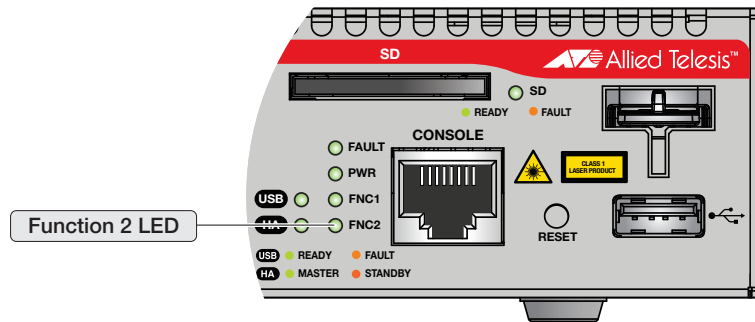

Figure 14. Function 2 LED

## USB Port

---

The management panel has a USB port which is shown in Figure 15. You may also use the port for the following maintenance purposes.

- ❑ Store configuration files on a USB device and copy the files to routers whose settings have been lost or corrupted
- ❑ Update the management firmware on the routers

The USB port is USB2.0 type-A compatible.

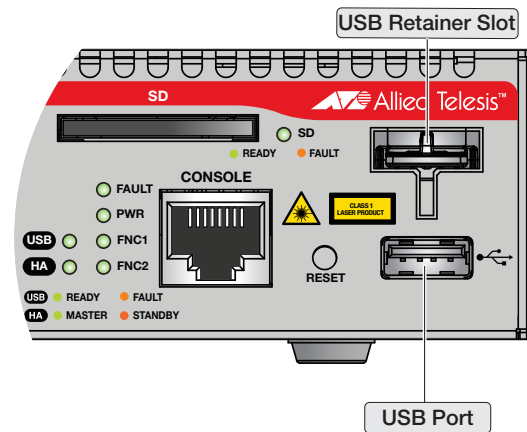

Figure 15. USB port

## USB Retainer Slot

---

The management panel has a USB retainer slot which is shown in Figure 16. You can use the USB retainer kit and the USB retainer slot to prevent the USB device from falling out the USB port.

---

### Note

Cable ties are designed to be used only once. Before you tighten them make sure they are positioned where you want them.

---

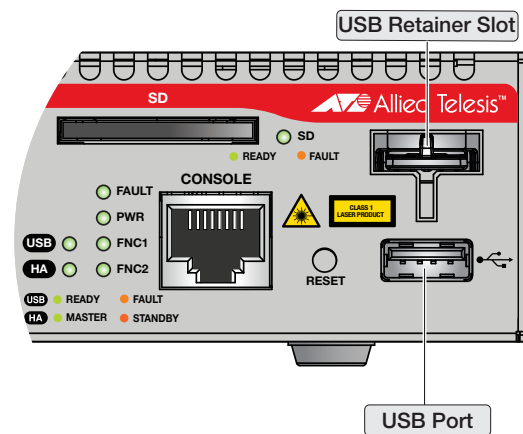

Figure 16. USB retainer slot

The following steps describe how to use the USB retainer kit and the USB retainer slot.

1. To fit the shape of the USB device, cut the USB retainer to an appropriate size and stick the double-side adhesive tape onto the back

of the USB retainer as shown in Figure 17.

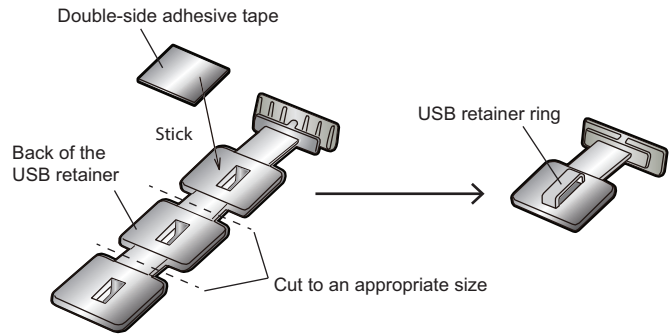

Figure 17. USB retainer

2. Mount the USB device into the USB port and then attach the H-shaped tip of the USB retainer to the USB retainer slot as shown in Figure 18.

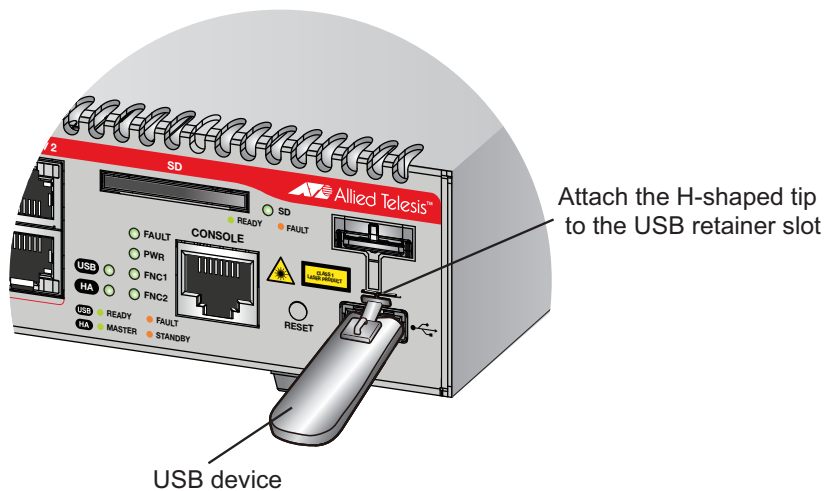

Figure 18. Attaching the USB retainer

3. Stick the double-side adhesive tape onto the back of the USB retainer. Wrap the cable tie around the USB device and pass the flat side through the USB retainer ring. Move the arm into position and the buckle of the cable tie under the device and tighten the tie.

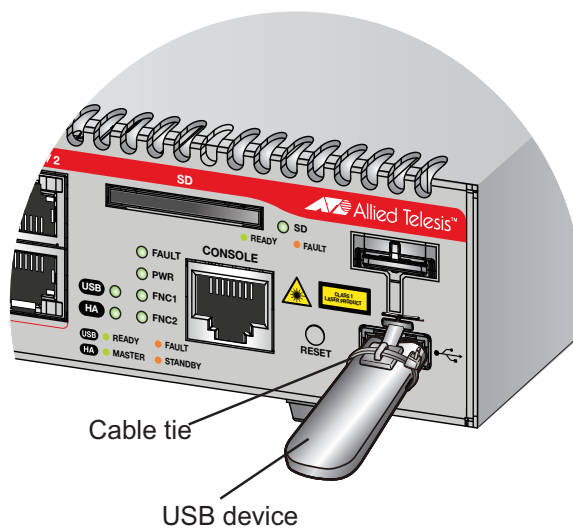

Figure 19. Attaching the cable tie

## SD Card Slot

---

The management panel has an SD card slot which is shown in Figure 20. You may use the port for the following maintenance purposes.

- ❑ Store configuration files on flash drives and restore the files to routers whose settings have been lost or corrupted
- ❑ Used for autoboot feature
- ❑ Update the management firmware on the routers

The SD card slot supports SDSC cards with storage capacity up to 2GB and SDHC cards with storage capacity up to 32GB.

---

### Note

SDXC cards are not supported.

---

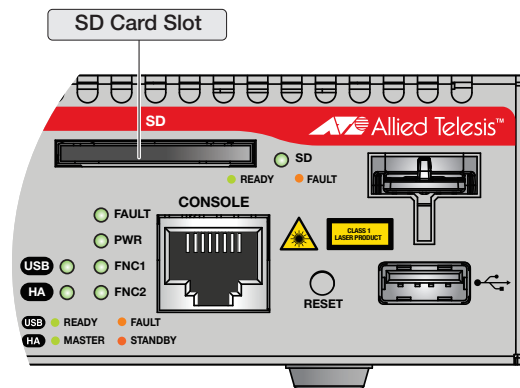

Figure 20. SD card slot

## Console Port

The Console port is used to establish a management session with the router to configure its features and parameter settings. The Console port is shown in Figure 21. This type of management uses serial RS-232 and is commonly referred to as local or out-of-band management because it is not conducted over your network. To perform local management, you must be at the location of the router and must use the management cable included with the router.

To establish a local management session with the router, connect a terminal or a personal computer with a terminal emulation program to the Console port, which has an RJ-45 style (8P8C) connector, using the provided management cable. The cable has RJ-45 style (8P8C) and DB-9 (D-sub 9-pin female) connectors.

The Console port is set to the following specifications.

- Default baud rate: 9600 bps
- Supported baud rate: 9600 bps, 14400 bps, 19200 bps, 28800 bps, 38400 bps, 57600 bps, 115200 bps
- Data bits: 8
- Parity: None
- Stop bits: 1
- Flow control: None

---

### Note

These settings are for a DEC VT100 or ANSI terminal, or an equivalent terminal emulation program.

---

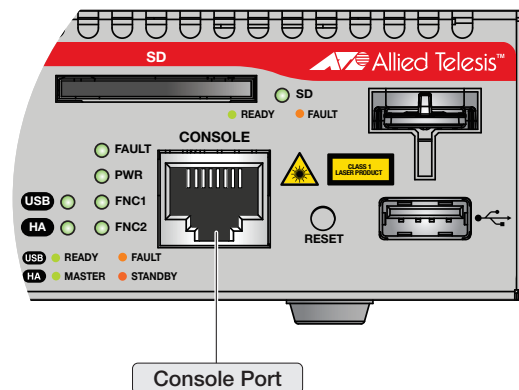

Figure 21. Console port



## Reset Button

---

The reset button is located between the Console port and the USB port. You may use the reset button to restore the router to its factory default settings or reboot the router.

- ❑ To return to the factory default settings, press and hold the reset button for at least 5 seconds, and then release the button.
- ❑ To return to the normal configuration and reboot the router, press and hold the reset button for at least 1 second but less than 5 seconds, and then release the button.

---

### Note

You won't lose files that contain user information by rebooting the router.

---

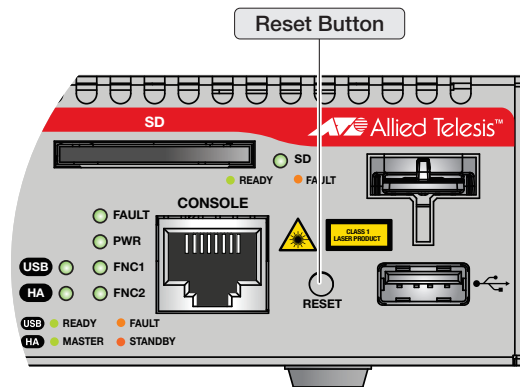

Figure 22. Reset button

## Power Supply

---

Each router has an internal power supply with a single AC power supply socket on the back panel. A power cable is supplied with the router. You can use the On/Off switch on the back panel of the router to power the router on or off.

Refer to “Technical Specifications” on page 33 for the input voltage range.



### **Warning**

Power cord is used as a disconnection device. To de-energize equipment, disconnect the power cord.  E3

---

## Chapter 2

# Beginning the Installation

---

The chapter contains the following sections:

- “Reviewing Safety Precautions” on page 10
- “Choosing a Site for the Routers” on page 14
- “Unpacking the Router” on page 15

## Reviewing Safety Precautions

---

Review the following safety precautions before beginning the installation procedure.

---

### Note

Safety statements that have the  symbol are translated into multiple languages in the *Translated Safety Statements* document at [www.alliedtelesis.com/support](http://www.alliedtelesis.com/support).

---



---

### Warning

Class 1 Laser product.  L1

---



---

### Warning

Do not stare into the laser beam.  L2

---



---

### Warning

Do not look directly at the fiber optic cable ends or inspect the cable ends with an optical lens.  L6

---



---

### Warning

Class 1 LED product.  L3

---



---

### Warning

To prevent electric shock, do not remove the cover. No user-serviceable parts inside. This unit contains hazardous voltages and should only be opened by a trained and qualified technician. To avoid the possibility of electric shock, disconnect electric power to the product before connecting or disconnecting the LAN cables.  
 E1

---



---

### Warning

Do not work on equipment or cables during periods of lightning activity.  E2

---



**Warning**

Power cord is used as a disconnection device. To de-energize equipment, disconnect the power cord. E3

---



**Warning**

Class I Equipment. This equipment must be earthed. The power plug must be connected to a properly wired earth ground socket outlet. An improperly wired socket outlet could place hazardous voltages on accessible metal parts. E4

---

---

**Note**

Pluggable Equipment. The socket outlet shall be installed near the equipment and shall be easily accessible. E5

---



**Caution**

Air vents must not be blocked and must have free access to the room ambient air for cooling. E6

---



**Warning**

Operating Temperatures. All the routers are designed for a maximum ambient temperature of 50° degrees C.

---

---

**Note**

All Countries: Install product in accordance with local and National Electrical Codes. E8

---



**Warning**

Only trained and qualified personnel are allowed to install or replace this equipment. E14

---



**Caution**

Circuit Overloading: Consideration should be given to the connection of the equipment to the supply circuit and the effect that overloading of circuits might have on overcurrent protection and supply wiring. Appropriate consideration of equipment nameplate ratings should be used when addressing this concern. E21

---



**Caution**

Risk of explosion if battery is replaced by an incorrect type. Replace only with the same or equivalent type recommended by the manufacturer. Dispose of used batteries according to the manufacturer's instructions.

**Attention:** Le remplacement de la batterie par une batterie de type incorrect peut provoquer un danger d'explosion. La remplacer uniquement par une batterie du même type ou de type équivalent recommandée par le constructeur. Les batteries doivent être éliminées conformément aux instructions du constructeur.  E22

---



**Warning**

Mounting of the equipment in the rack should be such that a hazardous condition is not created due to uneven mechanical loading.  E25

---

---

**Note**

Use dedicated power circuits or power conditioners to supply reliable electrical power to the device.  E27

---

---

**Note**

If installed in a closed or multi-unit rack assembly, the operating ambient temperature of the rack environment may be greater than the room ambient temperature. Therefore, consideration should be given to installing the equipment in an environment compatible with the manufacturer's maximum rated ambient temperature (T<sub>mra</sub>).  E35

---



**Caution**

Installation of the equipment in a rack should be such that the amount of air flow required for safe operation of the equipment is not compromised.  E36

---



**Warning**

Reliable earthing of rack-mounted equipment should be maintained. Particular attention should be given to supply connections other than direct connections to the branch circuits (e.g., use of power strips).  E37

---



**Caution**

The unit does not contain serviceable components. Please return damaged units for servicing. ⚡ E42

---



**Warning**

When you remove an SFP module from this product, the case temperature of the SFP may exceed 40° C (158° F). Exercise caution when handling with unprotected hands. ⚡ E43

---

## Choosing a Site for the Routers

---

Observe these requirements when planning the installation of the router.

- ❑ If you plan to install the routers in an equipment rack, check to be sure that the rack is safely secured so that it will not tip over. Devices in a rack should be installed starting at the bottom, with the heavier devices near the bottom of the rack.
- ❑ If you plan to install the routers on a table, check to be sure that the table is level and stable.
- ❑ The power outlet should be located near the routers and be easily accessible.
- ❑ The site should allow for easy access to the ports on the front of the routers, so that you can easily connect and disconnect cables, and view the port LEDs.
- ❑ The site should allow for adequate air flow around the unit and through the cooling vents on the front and rear panels. (The ventilation direction in units that have a cooling fan is from front to back, with the fan on the back panel drawing the air out of the unit.)
- ❑ The site should not expose the routers to moisture or water.
- ❑ The site should be a dust-free environment.
- ❑ The site should include dedicated power circuits or power conditioners to supply reliable electrical power to the network devices.
- ❑ Do not install the routers in a wiring or utility box because it will overheat and fail from inadequate airflow.



### **Warning**

Routers should not be stacked on top of one another on a table or desktop because that could present a personal safety hazard if you need to move or replace routers.

---



## Unpacking the Router

Figure 1 lists the items that come with the AT-AR3050S and AT-AR4050S routers. If any item is missing or damaged, contact your Allied Telesis sales representative for assistance. You should retain the original packaging material in the event you need to return the unit to Allied Telesis.

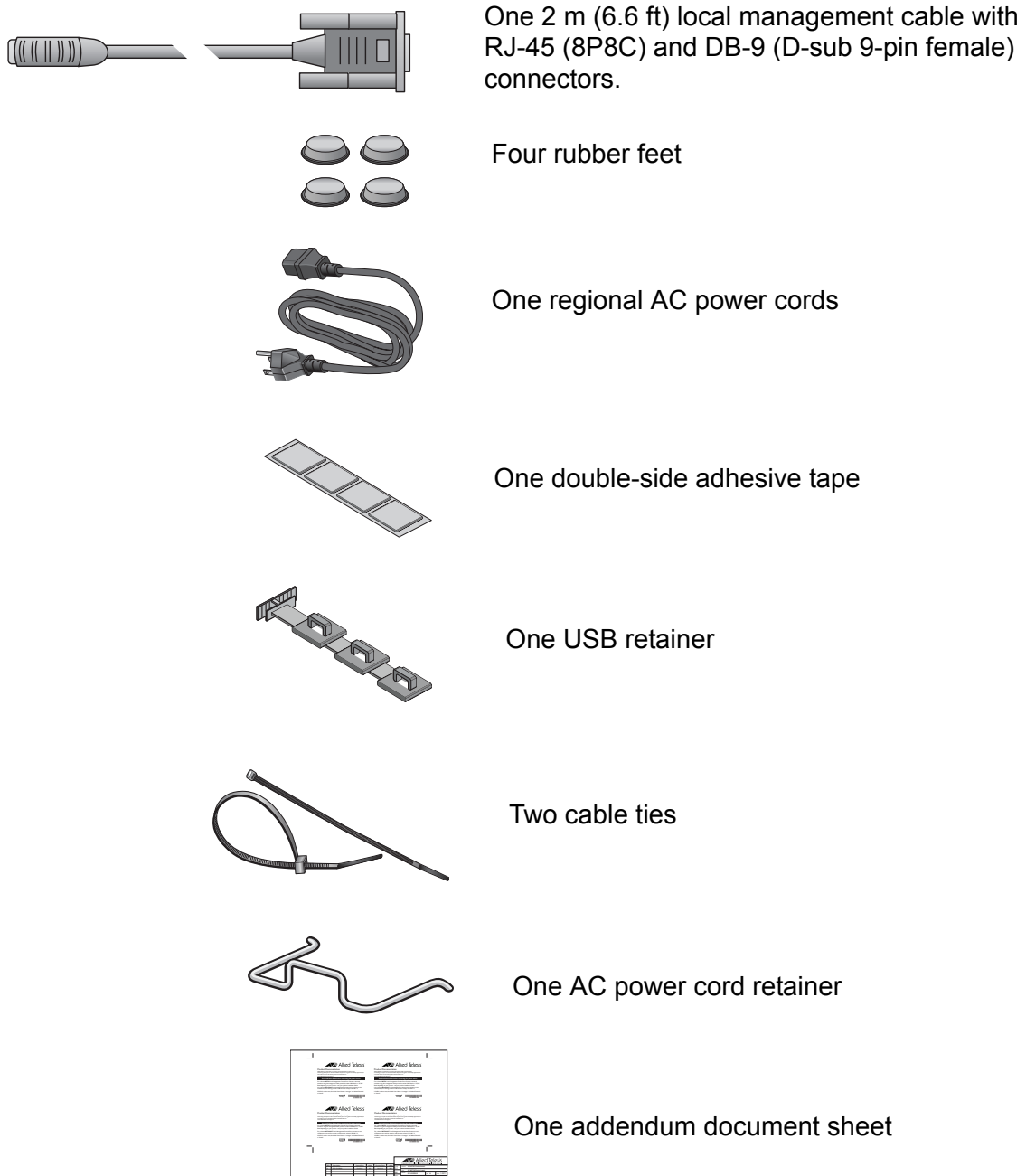

Figure 1. Components of the AT-AR3050S and AT-AR4050S routers



## Chapter 3

# Installing the Router and Powering on the Router

---

The procedures in this chapter are:

- ❑ “Installing the Power Cord Retaining Clip” on page 18
- ❑ “Installing the Router on a Table or Desktop” on page 19
- ❑ “Fitting Rubber Feet” on page 20
- ❑ “Installing the Router in an Equipment Rack” on page 21
- ❑ “Installing the Router on a Wall” on page 25
- ❑ “Connecting AC Power to a Power Supply Module” on page 28
- ❑ “Monitoring the Initialization Processes” on page 31

---

**Note**

The procedures apply to both the AT-AR3050S and AT-AR4050S routers.

---

## Installing the Power Cord Retaining Clip

---

Perform the following procedures to install the power cord retaining clip on the power supply module.



### Warning

Power cord is used as a disconnection device. To de-energize equipment, disconnect the power cord. ⚡ E3

---

1. Locate the power cord retaining clip, shown in Figure 2.

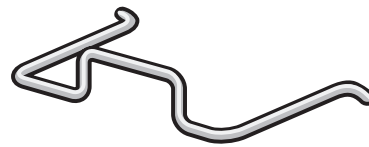

Figure 2. Power cord retaining clip

2. Install the clip on the AC power connector on the power supply module. With the 'u' of the clip facing down, press the sides of the clip forward the center and insert the short ends into the holes in the retaining bracket, as shown in Figure 3.

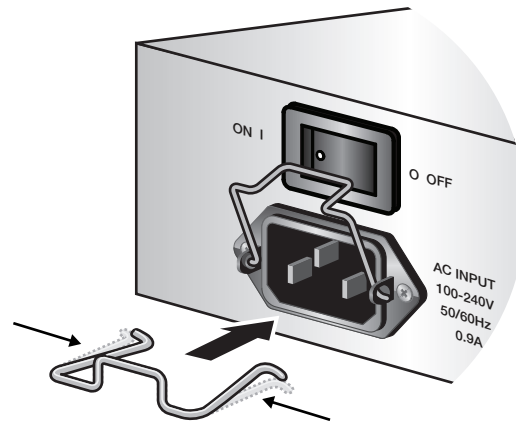

Figure 3. Inserting the retaining clip into the retaining bracket

## Installing the Router on a Table or Desktop

---

You may install the routers on a table or desktop. Here are the guidelines to selecting a site.

- The table should be level and stable.
- The power outlet should be located near the routers and be easily accessible.
- The site should allow for easy access to the ports on the front of the routers, so that you can easily connect and disconnect cables, and view the port LEDs.
- The site should allow for adequate air flow around the units and through the cooling vents on the front and rear panels. (The ventilation direction is from front to back, with the fan on the back panel drawing the air out of the unit.)
- The site should not expose the routers to moisture or water.
- The site should be a dust-free environment.
- The site should include dedicated power circuits or power conditioners to supply reliable electrical power to the network devices.
- The rubber feet on the bottom of the routers should be left on for table or desktop installation.



### **Warning**

Do not stack routers on top of one another on a table or desktop because that could present a personal safety hazard if you need to move or replace routers.

---

After placing the router on the table or desktop, go to Chapter 4, “Cabling the Networking Ports” on page 37 to connect the network cables to the ports on the router.

## Fitting Rubber Feet

---

If your routers do not already have rubber feet fitted, fit these as follows:

1. Remove all equipment from the package and store the packaging material in a safe place.
2. Turn the router over and place it on a table.
3. Remove the adhesive rubber feet from the packaging and press them firmly onto the base of the router, as shown in Figure 4.

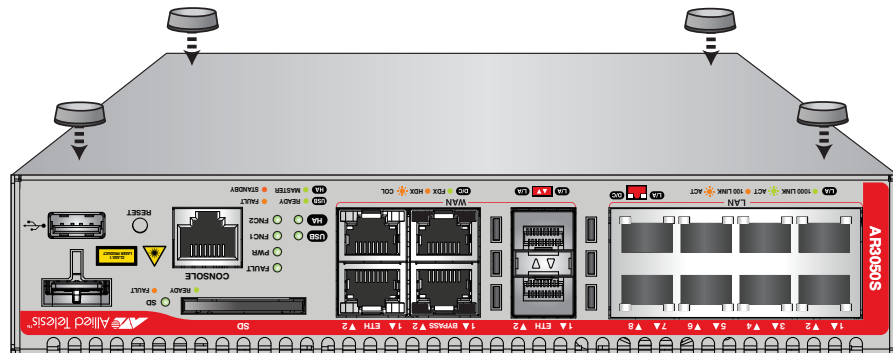

Figure 4. Attaching the rubber feet

4. Turn the router over again and place it on a flat, secure surface (such as a desk or table) leaving ample space around the unit for ventilation.

## Installing the Router in an Equipment Rack

---

This procedure requires the following items:

- Eight bracket screws (not provided)
- Two equipment rack brackets (not provided)
- Two handles (not provided)
- Four handle screws (not provided)
- Flat-head screwdriver (not provided)
- Cross-head screwdriver (not provided)
- Four standard equipment rack screws (not provided)

---

**Note**

Rack mount kits can be purchased separately from your Allied Telesis dealer.

---

---

**Note**

You can mount two routers side-by-side in a drawable tray with the AT-RKMT-J15 rack mount kit. The AT-RKMT-J15 rack mount kit can be purchased separately from your Allied Telesis dealer.

---

Installation guidelines can be found in “Choosing a Site for the Routers” on page 14. Here is the procedure for installing the routers in a 19-inch equipment rack.

**Caution**

The chassis may be heavy and awkward to lift. Allied Telesis recommends that you get assistance when mounting the chassis in an equipment rack. *GE* E28

---

1. Place the unit upside down on a level, secure surface, as shown in Figure 5.

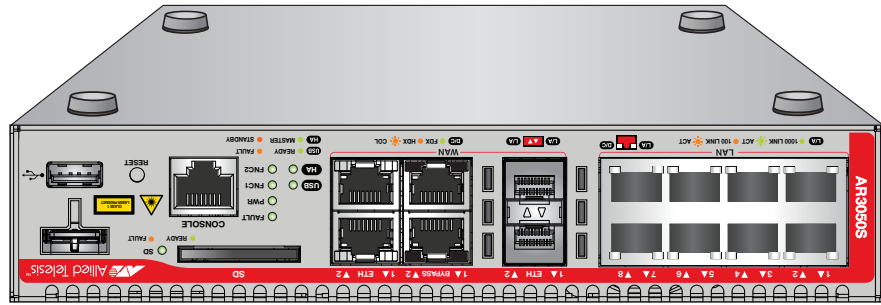

Figure 5. Turning the router upside down

2. If rubber feet are attached to the base of the router, remove them by prising off with a flat-head screwdriver, as shown in Figure 6, then turn the router back over.

---

**Note**

The rubber feet is an adhesive backed polyurethane product. Using a screwdriver to pry the rubber feet kit off the metalwork may destroy the adhesive in the removal process.

---

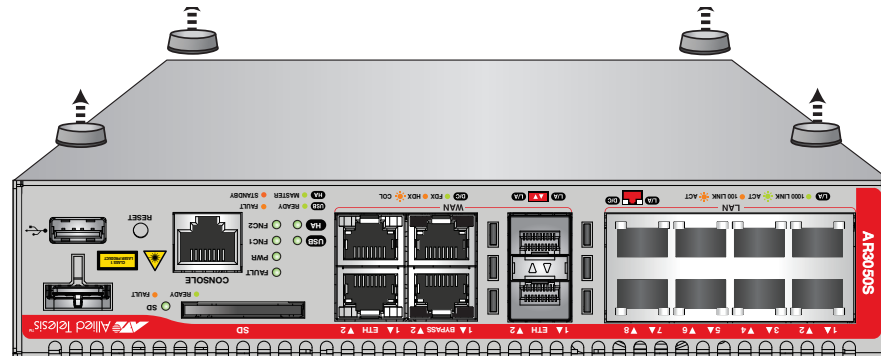

Figure 6. Removing the rubber feet

3. Turn the router over.



4. Use the four handle screws to screw the handles to the wider side of each bracket, as show in Figure 7.

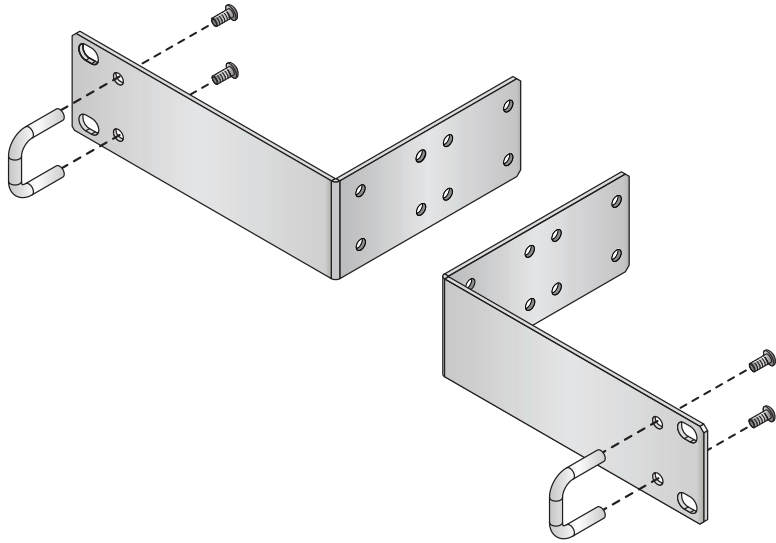

Figure 7. Attaching handles to the brackets

5. Use the eight bracket screws to screw the two rack mount brackets to the sides of the router, as shown in Figure 8.

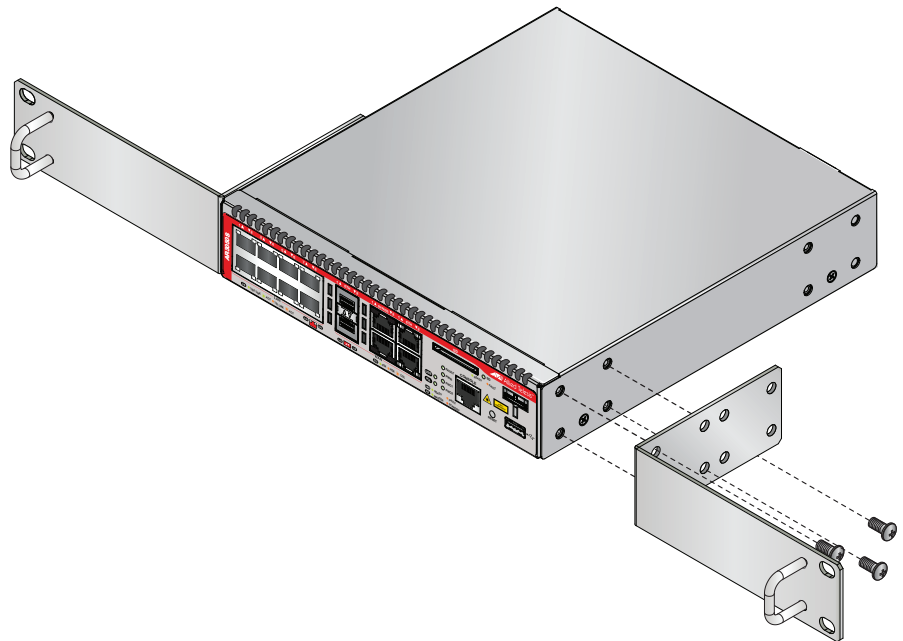

Figure 8. Attaching the equipment rack brackets

6. While another person holds the router in the equipment rack, secure it using standard equipment rack screws, as shown in Figure 9.

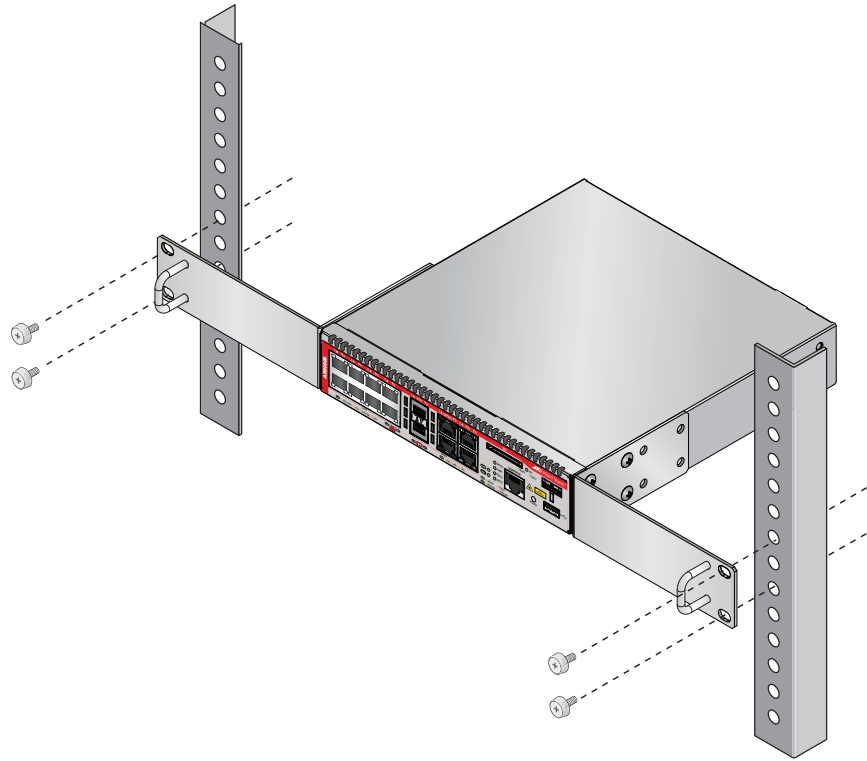

Figure 9. Mounting the router horizontally in an equipment rack

7. Go to Chapter 4, “Cabling the Networking Ports” on page 37, to connect the network cables to the ports on the router.

## Installing the Router on a Wall

---

This procedure requires the following items:

- ❑ A wall mount kit (not provided)
- ❑ Two equipment rack brackets (not provided)
- ❑ Cross-head screwdriver (not provided)
- ❑ If you are fixing the routers to a solid masonry or hollow wall, you need equipment to drill a 6 mm hole. The wall mount kit is supplied with screws and rawplugs to fasten the brackets to a masonry or plasterboard wall. If you are fixing the routers to a wooden wall, the screws are self-tapping.

---

**Note**

Wall mount kits can be purchased separately from your Allied Telesis dealer.

---

To install the routers on a wall, perform the following procedure:

1. Turn the router over and place it on a table.
2. If the rubber feet are attached to the bottom of the router, remove them by prising off with a flat-head screwdriver.
3. Orient the brackets against the sides of the router, and secure them to the unit with the 16 brackets screws included in the wall mount kit. See Figure 10.

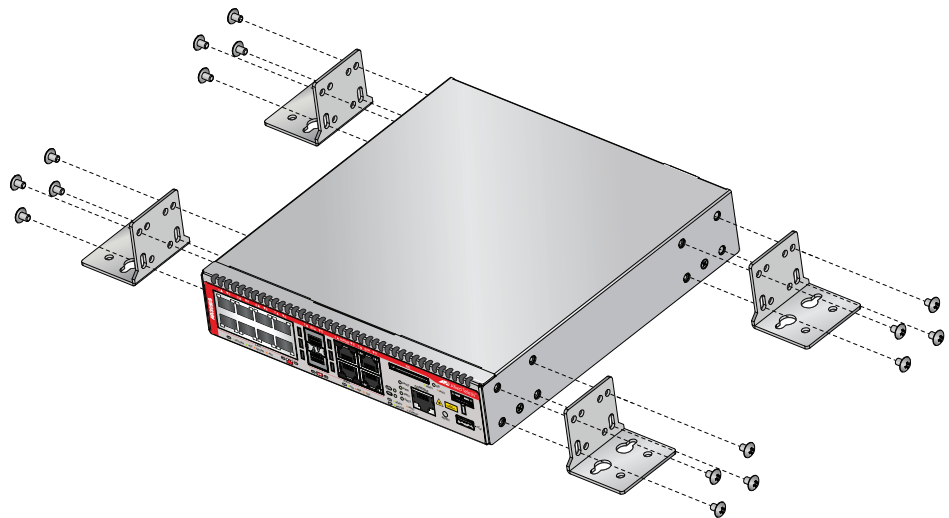

Figure 10. Attaching the wall mount brackets to the side of the router

4. Have another person hold the router at the wall location where the router is to be installed, while you use a pencil or pen to mark the wall with the locations of the holes in the brackets. The router should be oriented such that its front faceplate is facing to the left or right, and is vertically level. See Figure 11.

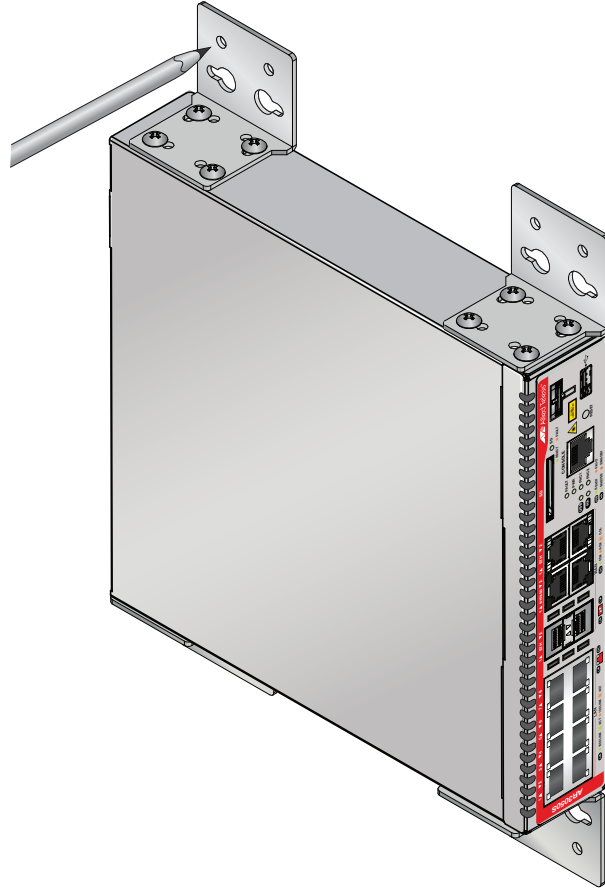

Figure 11. Making the anchor hole locations

6. While another person holds the router at the wall location, secure it to the wall using the 16 wall mounting screws. See Figure 12.

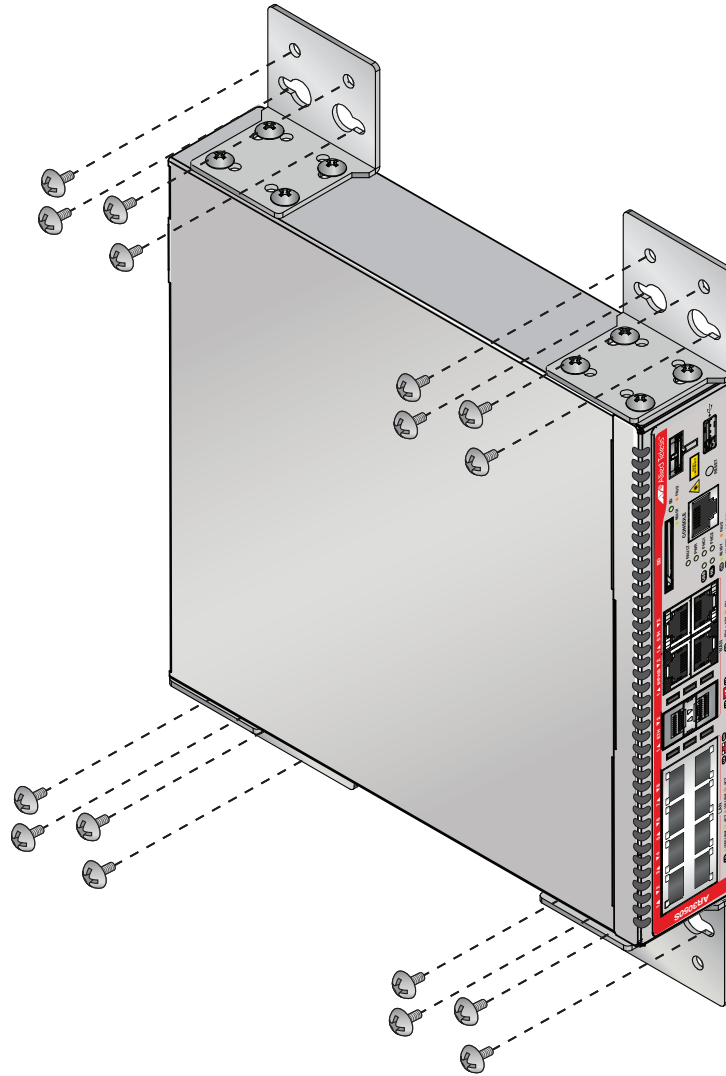

Figure 12. Securing the router to the wall

## Connecting AC Power to a Power Supply Module

---

The router has a single fan which pulls air into the chassis through the intake air vents to cool the chassis components. The air is discharged through the exhaust air vents on the top of the chassis front panel. See Figure 1 on page 15 and Figure 2 on page 15 for the location of the exhaust vents. See Figure 3 on page 16 for the location of the intake air vents.



### Warning

On both the AT-AR3050S and AT-AR4040S routers, keep the intake vents clear of any obstructions to insure proper cooling of the router components.

---

To power on the routers, perform the following procedure:

1. Position the power cord retaining clip in the up position, as shown in Figure 13.

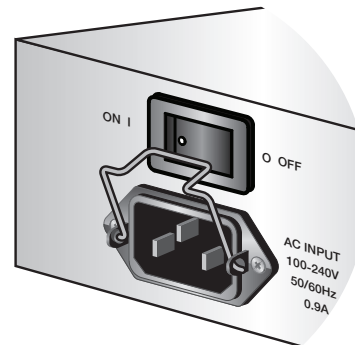

Figure 13. Power cord retaining clip in the up position

2. Plug the power cord into the AC power connector on the rear panel of the unit. Lower the power cord retaining clip to secure the power cord to the unit.



**Warning**

Power cord is used as a disconnected device. To de-energize equipment, disconnect the power cord. ⚡ E3

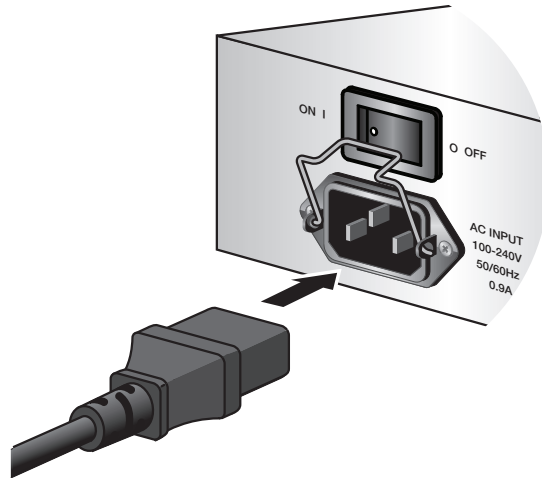

Figure 14. Connecting the AC power cord

3. Connect the other end of the power cord to an appropriate AC power outlet and switch the On/Off switch to On. For power specifications for the router, refer to Appendix A, “Technical Specifications” on page 33.
4. Verify that the POWER LED is green.

## Starting a Local Management Session

---

This procedure requires a terminal or a terminal emulator program and the management cable that comes with the router. To start a local management session on the router, perform the following procedure:

1. Connect the RJ-45 connector on the management cable to the Console port on the front panel of the router, as shown in Figure 15.

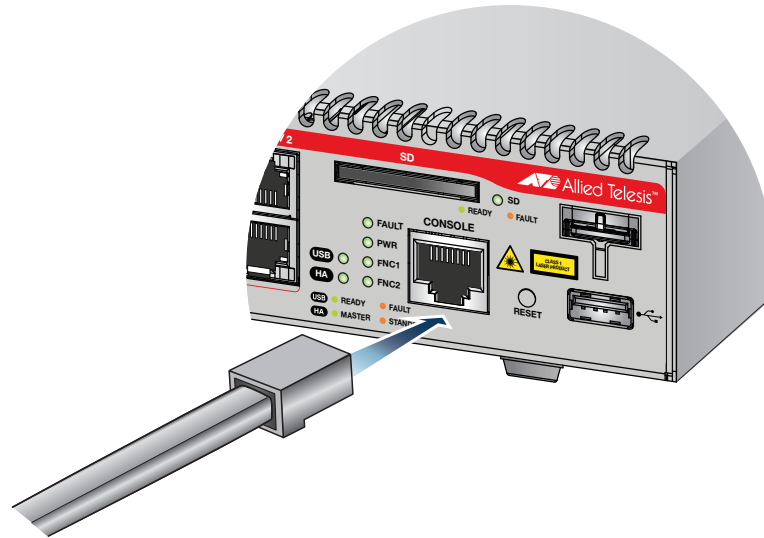

Figure 15. Connecting the Management Cable to the Console Port

2. Connect the other end of the cable to an RS-232 port on a terminal or PC with a terminal emulator program.
3. Configure the terminal or terminal emulator program as follows:
  - Baud rate: 9600 bps (9600 bps, 14400 bps, 19200 bps, 28800 bps, 38400 bps, 57600 bps, 115200 bps. The default is 9600 bps.)
  - Data bits: 8
  - Parity: None
  - Stop bits: 1
  - Flow control: None

---

### Note

The port settings are for a DEC VT100 or ANSI terminal, or an equivalent terminal emulator program.

---





```
Checking system reboot stability... [ OK ]
Starting base/cron... [ OK ]
Starting base/appmond... [ OK ]
Starting hardware/openhpi... [ OK ]
Starting hardware/timeout... [ OK ]
Starting base/inet... [ OK ]
Starting base/modules... [ OK ]
Received event modules.done
Received event board.inserted
Received event hardware.done
Starting network/startup... [ OK ]
Starting base/external-media... [ OK ]
Starting network/roboswitch... [ OK ]
Received event network.enabled

Initializing HA processes:
auth, hostd, hsl, irdpd, lacp, loopprot, mstp
nsm, ospf6d, pimd, ripd, ripngd, rmon, tunneld
bgpd, cntrd, imi, ospfd

Received event network.initialized
Received event standalone

Assigning Active workload to HA processes:
authd, hsl, imi, irdpd, lacpd, loopprotd, mstpd
nsm, ripd, rmond

Received event network.activated

Loading default configuration
warning: flash:/default.cfg does not exist, loading factory defaults.
..

done!
Received event network.configured
```

Figure 17. Router initialization messages (Continued)

## Chapter 4

# Cabling the Networking Ports

---

This chapter contains the following procedures:

- ❑ “Cabling the Twisted Pair Ports” on page 38
- ❑ “Installing Optional SFP Transceivers” on page 40

## Cabling the Twisted Pair Ports

---

Here are the guidelines to cabling the 10/100/1000Base-T twisted pair ports.

- ❑ The connectors on the cables should fit snugly into the ports, and the tabs should lock the connectors into place.
- ❑ The default setting for the wiring configurations of the ports is auto-MDI/MDI-X. The default setting is appropriate for router ports that are connected to 10/100Base-TX network devices that also support auto-MDI/MDI-X.
- ❑ The default auto-MDI/MDI-X setting is not appropriate for router ports that are connected to 10/100Base-TX network devices that do not support auto-MDI/MDI-X and have a fixed wiring configuration. For router ports connected to those types of network devices, you should disable auto-MDI/MDI-X and set the wiring configurations manually.
- ❑ The appropriate MDI/MDI-X setting for a router port connected to a 10/100Base-TX network device with a fixed wiring configuration depends on the setting of the network device and whether the router and network device are connected with straight-through or crossover cable. If you are using straight-through twisted pair cable, the wiring configurations of a port on the router and a port on a network device must be opposite each other, such that one port uses MDI and the other MDI-X. For example, if a network device has a fixed wiring configuration of MDI, you must disable auto-MDI/MDI-X on the corresponding router port and manually set it to MDI-X. If you are using crossover twisted pair cable, the wiring configurations of a port on the router and a port on a network device must be the same.
- ❑ The default speed setting for the ports is Auto-Negotiation. This setting is appropriate for ports connected to network devices that also support Auto-Negotiation.
- ❑ The default speed setting of Auto-Negotiation is not appropriate for ports connected to 10/100Base-TX network devices that do not support Auto-Negotiation and have fixed speeds. For those router ports, you should disable Auto-Negotiation and set the port's speed manually to match the speeds of the network devices.
- ❑ The 10/100/1000Base-T ports must be set to Auto-Negotiation, the default setting, to operate at 1000Mbps.
- ❑ The default duplex mode setting for the ports is Auto-Negotiation. This setting is appropriate for ports connected to network devices that also support Auto-Negotiation for duplex modes.
- ❑ The default duplex mode setting of Auto-Negotiation is not appropriate for ports connected to network devices that do not

support Auto-Negotiation and have a fixed duplex mode. You should disable Auto-Negotiation on those ports and set their duplex modes manually to avoid the possibility of duplex mode mismatches. A router port using Auto-Negotiation defaults to half-duplex if it detects that the end node is not using Auto-Negotiation, which can result in a mismatch if the end node is operating at a fixed duplex mode of full-duplex.

## Installing Optional SFP Transceivers

---

Review the following guidelines before installing SFP transceivers in the router.

- ❑ The transceiver can be hot-swapped; you do not need to power off the router to install a transceiver. However, always remove the cables before removing the transceiver.
- ❑ The operational specifications and fiber optic cable requirements of the transceivers are provided in the documents included with the devices.
- ❑ You should install a transceiver before connecting the fiber optic cable.
- ❑ Fiber optic transceivers are dust sensitive. Always keep the plug in the optical bores when a fiber optic cable is not installed, or when you store the transceiver. When you do remove the plug, keep it for future use.
- ❑ Unnecessary removal and insertion of a transceiver can lead to premature failure.



### Warning

A transceiver can be damaged by static electricity. Be sure to observe all standard electrostatic discharge (ESD) precautions, such as wearing an antistatic wrist strap, to avoid damaging the device.

---

To install an SFP transceiver, perform the following procedure:

1. Remove the dust plug from a transceiver slot on the router.

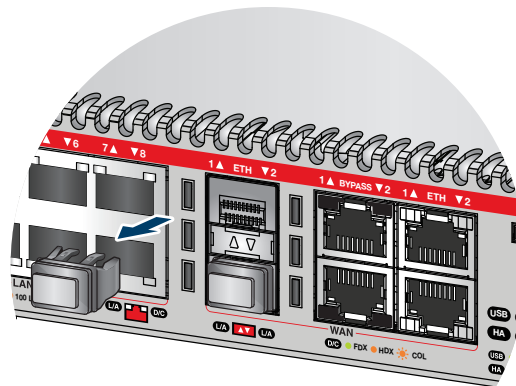

Figure 18. Removing the dust plug from an SFP slot

2. Remove the transceiver from its shipping container and store the packaging material in a safe location.
3. If you are installing the transceiver in a top slot, position the transceiver with the Allied Telesis label facing up. If you are installing the transceiver in a bottom slot, position the transceiver with the label facing down.
4. Gently slide the transceiver into the slot until it clicks into place, as shown in Figure 19.

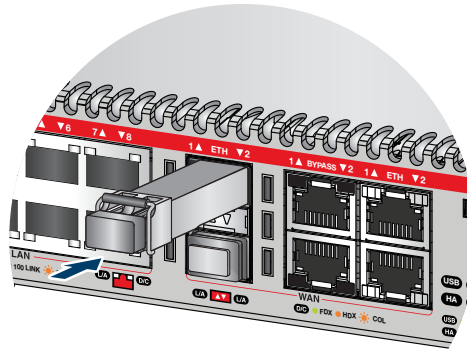

Figure 19. Installing an SFP transceiver

5. Remove the dust cover from the transceiver.

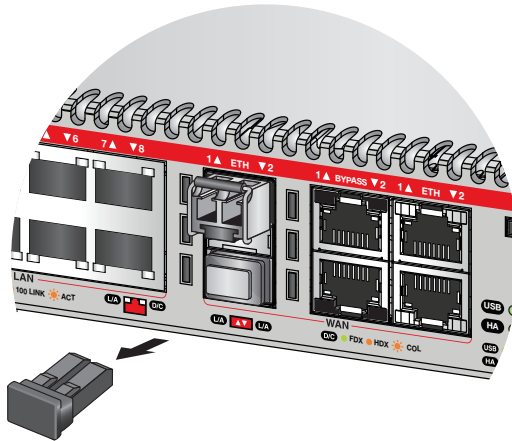

Figure 20. Removing the dust cover from an SFP transceiver

6. Verify the position of the handle on the SFP transceiver. If the transceiver is in a top slot, the handle should be in the upright position, as shown in Figure 21. If the transceiver is in a bottom slot, the handle should be in the down position. This secures the transceiver and prevents it from being dislodged from the slot.

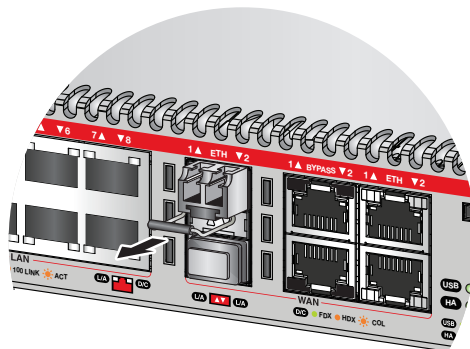

Figure 21. Positioning the SFP handle in the upright position

7. Connect the fiber optic cable to the transceiver, as shown in Figure 22. The connector on the cable should fit snugly into the port, and the tab should lock the connector into place.

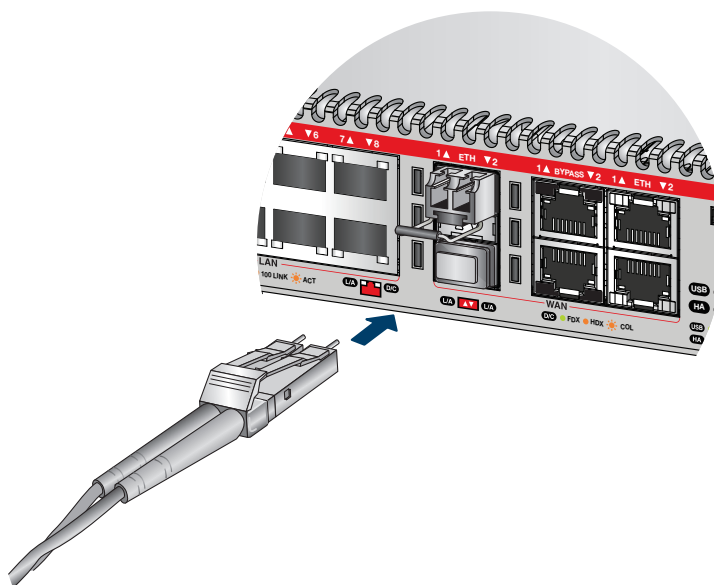

Figure 22. Connecting a fiber optic cable to an SFP transceiver

8. Repeat this procedure to install additional SFP transceivers.



## Chapter 5

# Troubleshooting

---

This chapter contains suggestions on how to troubleshoot the router if a problem occurs.

---

**Note**

For further assistance, please contact Allied Telesis Technical Support at [www.alliedtelesis.com/support](http://www.alliedtelesis.com/support).

---

**Problem 1:** The POWER LED on the front of the router is off.

**Solutions:** The unit is not receiving power. Try the following:

- Verify that the power cord is securely connected to the power source and to the AC connector on the back panel of the router.
- Verify that the power outlet has power by connecting another device to it.
- Try connecting the unit to another power source.
- Try a different power cord.
- Verify that the voltage from the power source is within the required levels for your region.

**Problem 2:** A twisted pair port on the router is connected to a network device but the port's Link/Activity/Speed LED is off.

**Solutions:** The port is unable to establish a link to a network device. Try the following:

- Verify that the network device connected to the twisted pair port is powered on and is operating properly.
- Verify that the twisted pair cable is securely connected to the port on the media converter channel and to the port on the remote network device. Verify that the twisted pair cable is securely connected to the port on the media converter channel and to the port on the remote network device.
- Verify that the port is connected to the correct twisted pair cable. This is to eliminate the possibility that the port is connected to the wrong network device, such as a powered off device.
- Try connecting another network device to the twisted pair port with a different cable. If the twisted pair port is able to establish a link,

then the problem is with the cable or the other network device.

- ❑ Verify that the twisted pair cable does not exceed 100 meters (328 feet).
- ❑ Verify that you are using the appropriate category of twisted pair cable: Category 3 or better for 10 Mbps operation and Category 5 and Category 5E for 100 and 1000 Mbps operation.

---

**Note**

A 1000BASE connection may require five to ten seconds to establish a link.

---

**Problem 3:** The Link/Activity LED for an SFP transceiver is off.

**Solutions:** The fiber optic port on the transceiver is unable to establish a link to a network device. Try the following:

- ❑ Verify that the network device connected to the fiber optic port is operating properly.
- ❑ Verify that the fiber optic cable is securely connected to the port on the media converter channel and to the port on the remote network device.
- ❑ Check that the SFP module is fully inserted in the slot.
- ❑ Verify that the operating specifications of the fiber optic ports on the SFP transceiver and the remote network device are compatible.
- ❑ Verify that the correct type of fiber optic cabling is being used.
- ❑ Verify that the port is connected to the correct fiber optic cable. This is to eliminate the possibility that the port is connected to the wrong remote network device, such as a powered off device.
- ❑ Try connecting another network device to the fiber optic port using a different cable. If the port is able to establish a link, then the problem is with the cable or with the other network device.
- ❑ Use the router's management software to verify that the port is enabled.
- ❑ If the remote network device is a management device, use its management firmware to determine whether its port is enabled.
- ❑ Test the attenuation on the fiber optic cable with a fiber optic tester to determine whether the optical signal is too weak (sensitivity) or too strong (maximum input power).

**Problem 4:** Network performance between a twisted pair port on the router and a network device is slow.

**Solutions:** There might be a duplex mode mismatch between the port and the network device. This occurs when a twisted pair port using Auto-

Negotiation is connected to a device with a fixed duplex mode of full duplex. If this is the cause of the problem, adjust the duplex mode of the port on the network device or on the router so that both ports are using the same duplex mode.

**Problem 5:** A port's Link/Activity/Speed LED is blinking.

**Solutions:** The link between the port and the network device is intermittent. Try the following:

- ❑ Connect another network device with a different cable to the port. If the Link LED remains steady on, then the problem is with the original cable or the network device.
- ❑ If the problem is with an SFP transceiver, check that the transceiver is fully inserted in the slot.



## Appendix A

# Technical Specifications

---

## Physical Specifications

---

### Dimensions (H x W x D)

Table 1. Product Dimensions

AT-AR3050S	42.5 mm x 210 mm x 220 mm (1.7 in. x 8.3 in. x 8.7 in.)
AT-AR4050S	42.5 mm x 210 mm x 220 mm (1.7 in. x 8.3 in. x 8.7 in.)

### Weights

Table 2. Product Weights

AT-AR3050S	1.8 kg (4.0 lb.)
AT-AR4050S	1.8 kg (4.0 lb.)

## Environmental Specifications

---

Table 3. Environmental Specifications

Operating Temperature (operation with a fan)	0° C to 50° C (32° F to 122° F)
Storage Temperature	-20° C to 60° C (-4° F to 140° F)
Operating Humidity	5% to 80% noncondensing
Storage Humidity	5% to 95% noncondensing
Maximum Operating Altitude	2,000 m (6,561 ft)
Product Noise Level	45 dB at 28°C
Maximum Nonoperating Altitude	3,000 m (9,843 ft)

## Power Specifications

---

### Maximum Power Consumptions

Table 4. Maximum Power Consumptions

AT-AR3050S	20 watts
AT-AR4050S	20 watts

### Input Voltages

Table 5. Input Voltages

AT-AR3050S	100-240 VAC, 0.9 A maximum, 50/60 Hz per input
AT-AR4050S	100-240 VAC, 0.9 A maximum, 50/60 Hz per input

## Certifications

---

Table 6. Product Certifications

EMC	AS/NZS CISPR22 class A EN55022 Class A EN55024 EN61000-3-2 EN61000-3-3 FCC Part 15 (CFR 47) Class A ICES-003 VCCI-A
Electrical Safety	IEC 60950-1 CAN/CSA-C22.2 No.60950-1 EN 60950-1 UL 60950-1
Laser Safety	EN60825-1
Environmental Compliance	2011/65/EU RoHS Directive
CE Marking	2006/95/EC Low Voltage Directive 2004/108/EC EMC Directive

## RJ-45 Twisted Pair Port Pinouts

Figure 18 illustrates the pin layout of the RJ-45 connectors and ports.

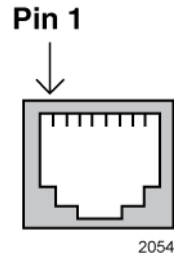

Figure 18. RJ-45 Socket Pin Layout (Front View)

Table 7 on page 35 lists the pin signals for 10 and 100 Mbps.

Table 7. Pin Signals for 10 and 100 Mbps

Pin	MDI Signal	MDI-X Signal
1	TX+	RX+
2	TX-	RX-
3	RX+	TX+
4	Not used	Not used
5	Not used	Not used
6	RX-	TX-
7	Not used	Not used
8	Not used	Not used

Table 8 lists the pin signals when a port operating at 1000 Mbps.

Table 8. Pin Signals for 1000 Mbps

Pinout	Pair
1	Pair 1 +
2	Pair 1 -
3	Pair 2 +
4	Pair 3 +

Table 8. Pin Signals for 1000 Mbps (Continued)

5	Pair 3 -
6	Pair 2 -
7	Pair 4 +
8	Pair 4 -

## RJ-45 Style Serial Console Port Pinouts

---

Table 9 lists the pin signals of the RJ-45 style serial Console port.

Table 9. RJ-45 Style Serial Console Port Pin Signals

Pin	Signal
1	Looped to pin 8.
2	Looped to pin 7.
3	Transmit Data
4	Ground
5	Ground
6	Receive Data
7	Looped to pin 2.
8	Looped to pin 1.